

SONOFF

TRVZB

User manual V1.1

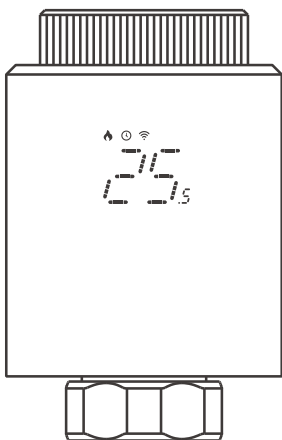

Thermostatic Radiator Valve



<https://sonoff.tech/product-review/tutorial/adapter-selection-guide/>

拆下旧的恒温头，检查是否需要阀门适配器，扫码或输入网址选取阀门适配器。



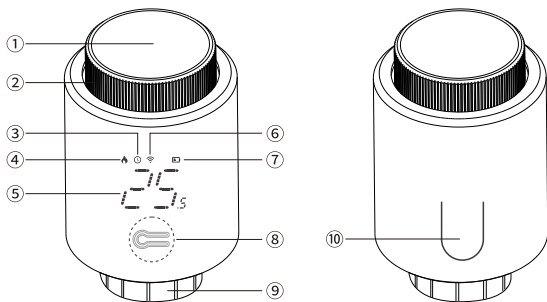

产品介绍



- ① 中键
- ② 旋钮
- ③ 自动模式
- ④ 加热状态
- ⑤ 设定的目标温度

- ⑥ 联网图标
- ⑦ 低电量提醒
- ⑧ 配置键(取下外壳后可见)
- ⑨ 暖气阀接口
- ⑩ 电池仓锁扣

屏幕显示及说明

屏幕显示	说明
	<p>开窗检测功能</p> <p>首先进入APP主界面开启开窗检测功能,设备将自动识别是否开窗,当检测到有冷气进入,4.5分钟内温度下降超过1.5°C,则启动开窗功能,此时屏幕显示“OP”,设温温度为12°C。</p> <p>注:启动开窗功能后,以下操作都会终止开窗功能生效:</p> <ol style="list-style-type: none"> 1.APP或设备端设温操作 2.4.5分钟内检测到温度上升超过1.5°C 3.30分钟内APP端和设备端没有任何操作。
	<p>防钙化功能</p> <p>温控器会在每周一上午12:00进行一次例行除钙,防止阀门钙化,除钙期间,屏幕上会显示“CR”</p>
	<p>童锁功能</p> <p>长按“中键”3秒,屏幕显示“LC”,童锁激活;锁屏后再次长按“中键”3秒,屏幕“LC”消失,童锁功能取消</p>
	<p>冬天外出不需要加热时,手动模式下,逆时针旋转(↺)旋钮至“OF”显示,此时设备阀门关闭,防冻功能启动。</p> <p>注:防冻功能启动后,当在房间温度低于5°C时启动,室温超过7°C时关闭,以防止散热器因冻结而损坏。</p>
	<p>电池电量不足(需要1周内更换新电池)</p>

功能特点

使用SONOFF温控阀,可以更准确地控制和达到您想要的温度。支持远程控制及定时,开窗检测帮助您节约能源,避免额外的能源浪费。并且搭配适配器几乎可以安装在任何阀门上。



远程控制



智能定时



精确的温度控制



历史数据记录



童锁



开窗检测

配网流程

1. 设备通电

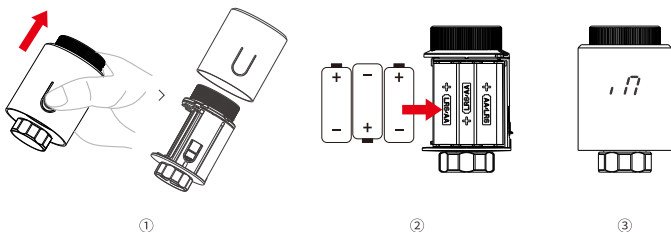

① 按住电池仓锁扣同时将外壳取出。

② 装入电池。

③ 通电后，屏幕显示“17”并闪烁。

2. 设备安装

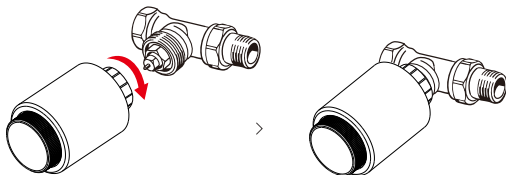

"17" 停止闪烁时，再将设备安装至阀门接口。

⚠ 如屏幕显示"FS"或"Ad"，请短按中键恢复显示"17"。

3. 设备调试

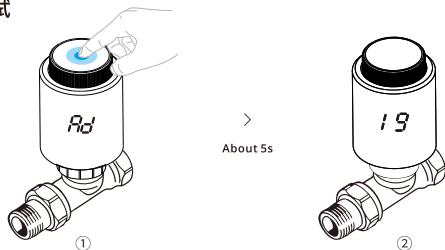

短按中键，“Ad”开始闪烁(图①)，等待约5秒，设备显示初始化界面(图②)，即调试完成。

4. 下载易微联App并添加SONOFF Zigbee网关

⊙ 设备支持其他无线协议为ZigBee 3.0的网关，具体以实际产品为准。

5. 将设备添加至Zigbee网关

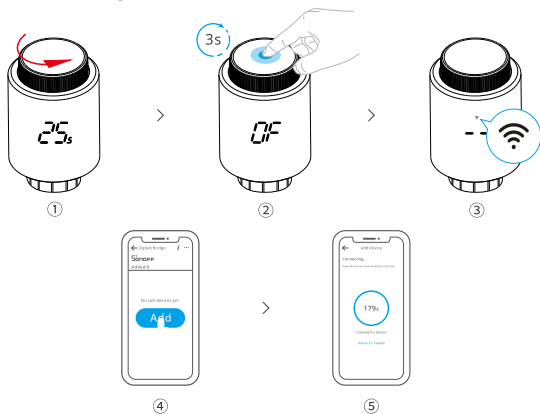

手动模式下，逆时针转动旋钮，屏幕显示“OF”时，长按中键3秒，屏幕联网图标“📶”闪烁，此时设备进入配网模式，然后打开App在网关主页添加设备即可。

⊙ 设备进入配网模式后，3分钟内没进行和网关配对，设备将退出配网状态。如需再次配网，请在屏幕显示“OF”时，长按中键3秒直到屏幕联网图标“📶”闪烁。

温控模式

设备分自动模式与手动模式，短按设备“中键”，可切换自动模式与手动模式。

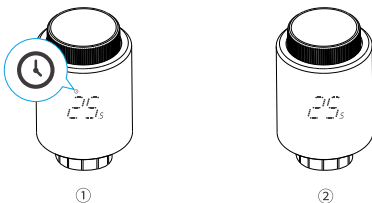

自动模式：屏幕显示图标“闹钟”为自动模式（图①）。

手动模式：屏幕图标“闹钟”消失为手动模式（图②）。

⊙ 配网操作必须保证设备处于手动模式下。

屏幕显示旋转

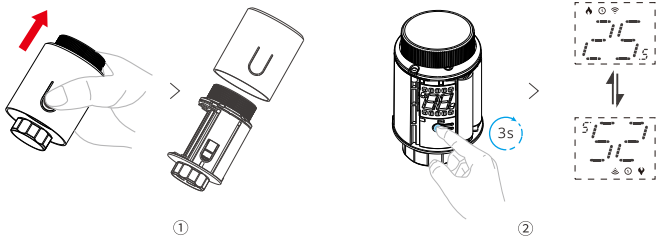

① 拆下外壳，

② 长按“配置键”3秒，可实现切换屏幕显示方向。

产品参数

产品型号	TRVZB
输入	4.5V \equiv (3x1.5V 电池)
电池型号	1.5V LR6碱性AA电池
无线连接	Zigbee 3.0
螺纹接口	M30x1.5mm
温度设定范围	4°C-35°C
工作温度	-10°C~50°C
工作湿度	5%-95% RH, 无冷凝
产品颜色	白色
外壳材料	PC
产品规格	59.4x59.4x95mm
微断开操作	1.B
污染等级	2
额定脉冲电压	500V

错误码问题及解决方案

错误代码	问题	解决方案
<i>F0</i>	温度传感器异常	联系售后人员
<i>F1</i>	阀门运转迟钝	检查安装情况和暖气阀
<i>F2</i>	调整幅度过宽	检查温控器是否扣紧
<i>F3</i>	调整幅度过小	检查暖气阀
<i>F4</i>	电池电量耗尽	更换电池
<i>F5</i>	未检测到阀门	检查是否安装阀门

恢复出厂设置

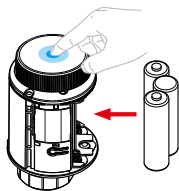

长按“中键”同时装入电池，屏幕显示“FR”并闪烁3秒后，设备恢复出厂设置并自动重启。

⚠ 恢复出厂设置后之前所有的设定将会清除。



<https://sonoff.tech/product-review/tutorial/adapter-selection-guide/>





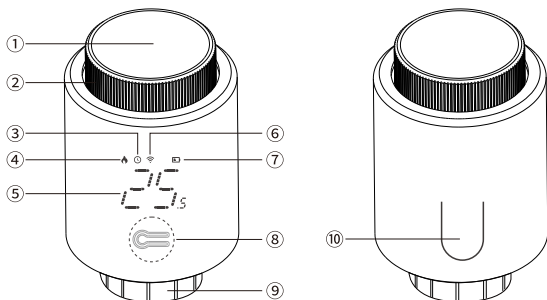

Remove the old thermostatic faucet and check if a valve adapter is needed, then scan the QR code or enter the URL to select the valve adapter.

Product introduction



- | | |
|----------------------|--|
| ① Middle button | ⑥ Internet connection |
| ② Rotary knob | ⑦ Low battery |
| ③ Auto | ⑧ Configuration key (under the dismantlable shell) |
| ④ Heating | ⑨ Heating valve interface |
| ⑤ Target temperature | ⑩ Battery case latch |

Screen display and introduction

Screen display	Introduction
	<p>Window opening detection function</p> <p>The device will automatically identify whether the window is opened after you enter the app interface to enable the window opening detection function. When cold air is detected and the temperature drops more than 1.5 °C within 4.5 minutes, the window opening function will be enabled. Alongside the enabling of the function, the screen displays "OP" and the temperature is set at 12 °C.</p> <p>Note: After the window opening function is enabled, the following operations will disable the window opening function:</p> <ol style="list-style-type: none"> 1. Temperature setting operation on App or device. 2. Temperature rises by more than 1.5°C within 4.5 minutes. 3. No operation on App or device within 30 minutes.
	<p>Anti-calcification function</p> <p>The temperature control valve will perform a routine calcium removal operation at 12:00 am every Monday to prevent calcification of the valve. During the operation, the screen will display "CA".</p>
	<p>Child lock function</p> <p>Press "Middle button" for 3 seconds, then the screen will display "LC", with child lock enabled. After the screen is locked, press "Middle button" for 3 seconds, then the "LC" on the screen will disappear, with child lock disabled.</p>
	<p>When heating is not needed in winter, turn knob counterclockwise () to the "OF" icon, then the device valve is closed and the antifreeze function is enabled.</p> <p>Note: After the antifreeze function is enabled when the room temperature is below 5 °C, the function will be enabled to prevent the radiator from being damaged by freezing. The function will be disabled when the room temperature exceeds 7 °C.</p>
	<p>Low battery (Battery needs to be replaced with a new one within 1 week)</p>

Features

With SONOFF Thermostatic Radiator Valve, you can control and reach the temperature you want more accurately. It allows remote control and timing. The window opening detection function helps you save energy and avoid additional energy waste. The matching adapters can be installed on almost any valve.



Remote Control



Smart Timing



Precise Temperature Control



Historical Data Record



Child Safety Lock



Open Window Detection

Pairing process

1. Power on the device

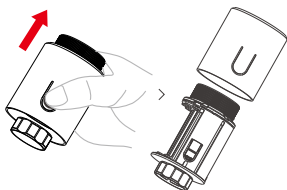

①

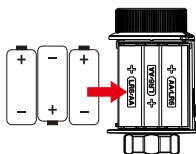

②



③

- ① Press the battery compartment latch while taking out the shell.
- ② Load the battery.
- ③ After powering on, the screen displays " 17 " and flashes.

2. Device installation

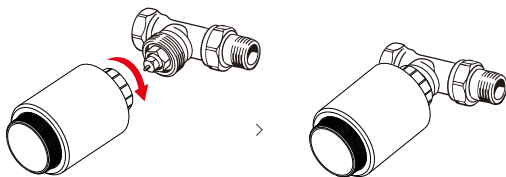

When " *f* " stops flashing, install the device to the valve interface.

ⓘ If the screen displays " *FS* " or " *Rd* ", press the middle button and " *f* " will display again.

3. Device debugging

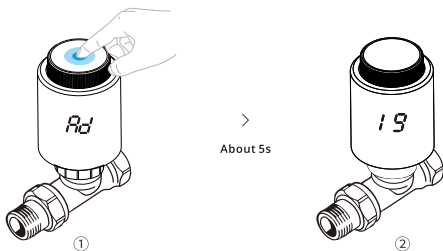

Short press the middle button, and " *Rd* " will flash (Figure ①). Wait for about 5 seconds, and the device will display the initialization interface (Figure ②), which means that debugging is completed.

4. Download the eWeLink App & Add SONOFF Zigbee gateway.

ⓘ The device can work with other gateways supporting Zigbee 3.0 wireless protocol. Detailed information is in accordance with the final product.

5. Add the device to Zigbee gateway

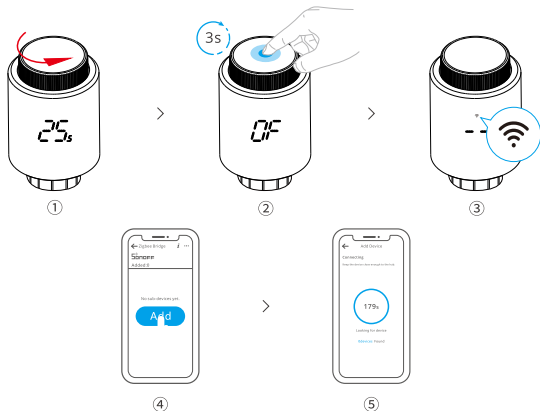

In manual mode, turn the knob counterclockwise. When the screen displays " OF ", press and hold the middle button for 3 seconds and the screen icon " ̶ " flashes. Now the device enters Pairing mode, then open the App and add the device in the gateway homepage.

- ⚠ If the device fails to pair with the gateway within 3 minutes after it enters Pairing mode, the device will exit the pairing status. If you want to pair again, please press and hold the middle button for 3 seconds until the icon " OF " flashes when the screen shows " ̶ ".

Temperature control mode

The device supports auto mode and manual mode. Shortly press "Middle button" to switch between the two modes.

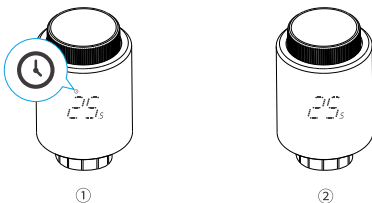

Auto mode:

When "🕒" is displayed on screen, it means the auto mode is on (Picture ①),

Manual mode:

When "🕒" disappears on screen, it means the manual mode is on (Picture ②).

⚠ Device pairing operation must be done in manual mode.

Screen display rotation

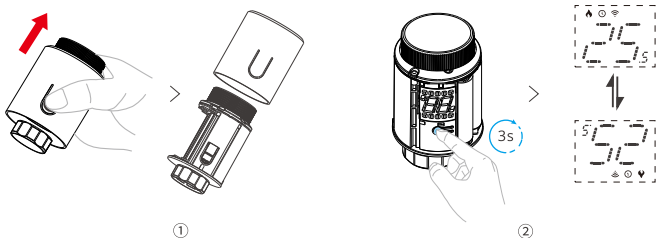

① Dismount the shell,

② Press "Configuration key" for 3 seconds to change the screen display direction.

Specifications

Model	TRVZB
Input	4.5V \equiv (3x1.5V AA Batteries)
Battery model	1.5V LR6 Alkaline AA Battery
Wireless connection	Zigbee 3.0
Threaded connection	M30x1.5mm
Temperature setting range	4°C-35°C
Working temperature	-10°C~50°C
Working humidity	5%-95% RH Non-condensing
Color	White
Casing material	PC
Product dimension	59.4x59.4x95mm
Disconnection means	Type 1.B
Pullution degree	2
Rated impulse voltage	500V

Error codes, problems and solutions

Error code	Problem	Solution
<i>F0</i>	Abnormal temperature sensor	Contact aftersales staff
<i>F1</i>	Slow valve operation	Check installation status and heating valve
<i>F2</i>	Excessively wide adjustment range	Check whether temperature controller is fastened
<i>F3</i>	Excessively small adjustment range	Check heating valve
<i>F4</i>	Battery runs out	Replace battery
<i>F5</i>	No valve detected	Check whether valve is installed

Factory reset

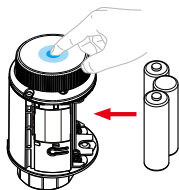

Press "Middle button" for a longer time and at the same time put batteries in, then the screen displays "FR" and blinks for 3 seconds. After that, the device is reset to factory settings and is automatically restarted.

ⓘ All previous settings will be removed after the device is reset to factory settings.

Scatola	Scatola	Manuale	Borsa
PAP 20	PAP 21	PAP 22	CPE 7
Carta	Carta	Carta	Plastica
RACCOLTA DIFFERENZIATA			
Verifica le disposizioni del tuo Comune. Separa le componenti e conferiscile in modo corretto.			

CAUTION

RISK OF EXPLOSION IF BATTERY IS REPLACED BY AN INCORRECT TYPE.
DISPOSE OF USED BATTERYIES ACCORDING TO THE INSTRUCTIONS

Do not short-circuit batteries.

Do not use new and old batteries together.

Do not use batteries of different types/manufacturers together.

Do not use batteries in reverse polarity

A battery which is leaking or has leaked before is not fit for use and should be thrown away.

Place the batteries into a plastic bag, without touching the batteries, put on gloves and an apronand, then put it into a recycling box at an electrical store.

When the battery which is leaking or has leaked before, in some cases, the circuit board of your device may be damaged and will no longer work. In that cases, you should take your device to a Recupel collection point and the battery to a Bebat collection point.

SAR Warning

Under normal use of condition, this equipment should be kept a separation distance of at least 20 cm between the antenna and the body of the user.

Dans des conditions normales d'utilisation, cet équipement doit être maintenu à une distance d'au moins 20 cm entre l'antenne et le corps de l'utilisateur.

WEEE Disposal and Recycling Information



All products bearing this symbol are waste electrical and electronic equipment (WEEE as in directive 2012/19/EU) which should not be mixed with unsorted household waste. Instead, you should protect human health and the environment by handing over your waste equipment to a designated collection point for the recycling of waste electrical and electronic equipment, appointed by the government or local authorities. Correct disposal and recycling will help prevent potential negative consequences to the environment and human health. Please contact the installer or local authorities for more information about the location as well as terms and conditions of such collection points.

For CE Frequency

Operation frequency Range:
Zigbee: 2405-2480MHZ

RF Output Power:
Zigbee: ≤10dBm

EU Declaration of Conformity

Hereby, Shenzhen Sonoff Technologies Co., Ltd. declares that the radio equipment type TRVZB is in compliance with Directive 2014/53/EU. The full text of the EU declaration of conformity is available at the following internet address:

<https://sonoff.tech/usermanuals>

SONOFF

Shenzhen Sonoff Technologies Co., Ltd.

3F & 6F, Bldg A, No. 663, Bulong Rd, Shenzhen, Guangdong, China

ZIP code: 518000

Service email: support@itead.cc

Website: sonoff.tech

MADE IN CHINA



FR

Cet appareil et
ses accessoires
se recycle

À DÉPOSER
EN MAGASIN



OU

À DÉPOSER
EN DÉCHÈTERIE



Points de collecte sur www.quefairedemesdechets.fr
Privilégiez la réparation ou le don de votre appareil !